



INSTALLATION & OWNER'S MANUAL

Wired Controller
MODEL: NC-75A



Thank you very much for purchasing our product.
Before using your unit, please read this manual carefully and keep it for future reference.

- This manual gives detailed description of the precautions that should be brought to your attention during operation.
- In order to ensure correct service of the wired controller please read this manual carefully before using the unit.
- For convenience of future reference, keep this manual after reading it.

CONTENTS

1 OPERATION

- 1.1 Operation precautions 01
- 1.2 Operation conditions 02
- 1.3 Main functions 02
- 1.4 User interface 03
- 1.5 Instructions for use 04
- 1.6 Further details 05

2 INSTALLATION

- 2.1 Safety precautions 06
- 2.2 Installation accessories 07
- 2.3 Installation dimensions 08

- 2.4 Installation method 09
 - 2.5 Schematic drawing of installation 16
-

1 OPERATION

1.1 Operation precautions

- Read the safety precautions carefully before installing, and must be obeyed.



WARNING

Means improper handling may lead to personal death or severe injury.



CAUTION

Means improper handling may lead to personal injury or property loss.

- This manual uses the following icons:



Prohibit



Follow the guide lines

Please entrust the distributor or professionals to install the unit. Before cleaning or maintenance, please cut off the power, and prohibit to use water for washing, to prevent electrical shock.

Do not operate by wet hand, to prevent electrical shock.
Do not use pesticide, disinfectant and flammability spray materials to spray directly, otherwise will cause fire or deformation.
Do not peel off the button and the cover by hand, to prevent electrical shock.

1.2 Operation conditions

Voltage input	DC 5V
Operating ambient temperature range	-10~43°C
Operating ambient humidity range	≤ RH90%

1.3 Main functions

1. Connected to IDU main control board via 5-core shielded cable;
2. Setting IDU operating status by tapping touch keys;
3. LED display.

1.4 User interface

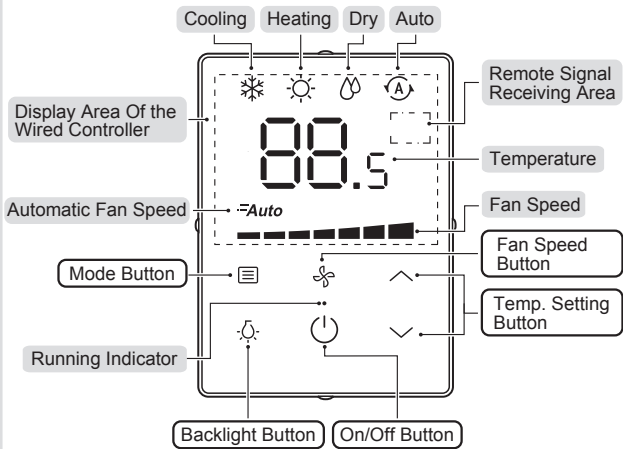

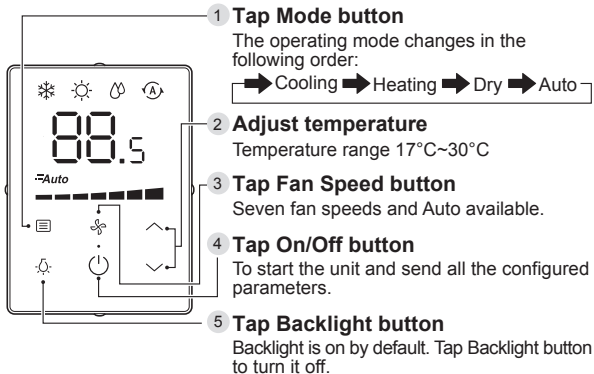
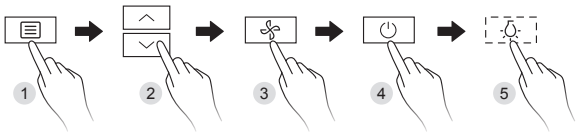

1.5 Instructions for use

1.5.1 Basic setting



1.6 Further details

1.6.1 Supplementary instructions

- Fan Speed button  :
Fan speed cannot be set in Dry/Auto mode (Auto displayed).
- Backlight mode:
 - 1) Steady On: means backlight is normally on.
Tapping  to start the unit can enter the backlight steady on mode.
If backlight is off, tapping  can switch to steady on mode.
 - 2) Auto Off: means backlight is automatically off after 4s.
If backlight is off, tapping any button (except backlight and On/Off) can switch to Auto Off mode.

1.6.2 Remote control receiving function

- Applies to specific models only.



CAUTION

Do not peel off the buttons and liquid crystal cover, to prevent electric shock!



2 INSTALLATION

2.1 Safety precautions

- Read the safety precautions carefully before installing the unit.
- Stated below are important safety issues that must be obeyed.



WARNING

- Please entrust the distributor or professionals to install the unit, do not install the unit by the user.
- Do not uninstall the unit randomly.
- The wiring should adapt to the wired controller current.
- The specified cables shall be applied in the wiring. No external force may be applied to the terminal.
- The circuit of wire controller is low voltage circuit, do not contact to the high voltage circuit, and can not be arranged in the same wiring pipe with the high circuit, the distance between the wiring pipes should at least more than 300~500mm.

- Do not connect transition or extended connection in the middle of the wirings of the wire controller.

2.2 Installation accessory

- Please confirm that all the following parts have been supplied.

No.	Name	Qty	Remarks
1	Wire controller	1	Used to control the IDU main unit.
2	M4×20 Philips head screw	4	Used to install the wired controller onto the wall.
3	Installation and operation manual	1	Used to guide the operation and installation of wired controller.
4	Plastic bolt	4	Used to install the wired controller onto the wall.
5	Connection cable set	1	Used to connect the IDU main control board and the wired controller.

- Please install the following accessories in the filed.

NO.	Name	Qty	Remarks
1	Shielded 5-core cable	1	RVVP-0.5 mm ² ×5, embedded into the wall
2	Wiring tubes (insulation suite)	1	Embedded into the wall; maximum wiring length: 15 m
3	Big Phillips screwdriver	1	Used to install cross recessed head screws
4	Small slotted screwdriver	1	Used to remove the bottom cover of wired controller

2.3 Installation dimensions

Before installation, refer to the mounting dimensions and the size of product below (unit: mm).

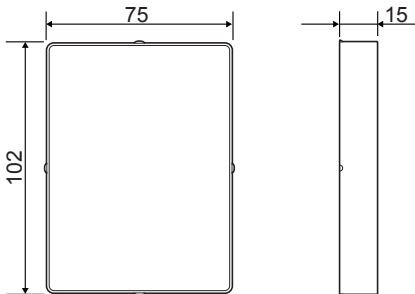

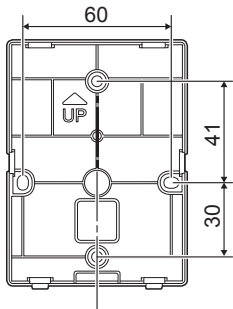

2.4 Installation method

2.4.1 Non-wall-mounted

1. Wiring requirements

- The two ends of the connection cable set are different. That with the larger 5-core plug is defined as terminal A, while that with the smaller 5-core plug is defined as terminal B.

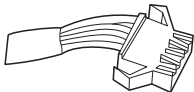

Terminal A

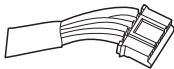

Terminal B

- Connect terminal A to the 5-core socket of the IDU main control board (See the figure below).

Supplied connection cable set
of IDU main control board

IDU Main control board

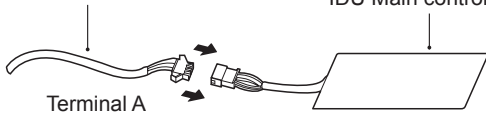

2. Insert a slotted-head screwdriver into the bottom slot of the wired controller, and rotate in the direction indicated to remove the rear cover of the wired controller.

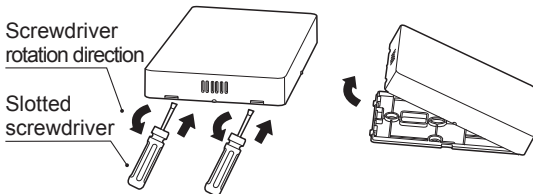

3. Take terminal B out of the FCU electric control box and pass it through the wiring hole in the rear cover of the wired controller. Connect terminal B to the 5-core socket on the PCB of wired controller. Then, restore the rear cover of wired controller and install the wired controller into the FCU electric control box with the display panel face-up, as shown below.

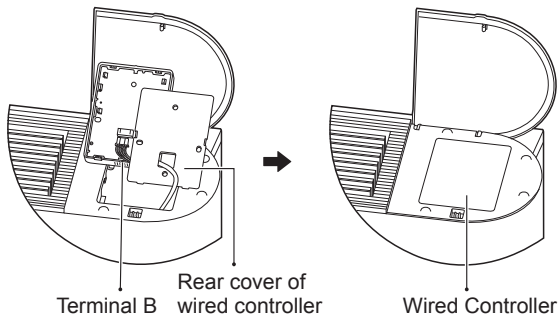

CAUTION

The wired controller can be installed on the left or right side of FCU, depending on the circumstances.

2.4.2. Wall-mounted

1. Wiring requirements

- Cut the connection cable set in the middle (unsheathed place). The section that includes terminal A is section A, while the section that includes terminal B is section B.
- Connect terminal A to the 5-core socket of the IDU main control board (See the figure below).

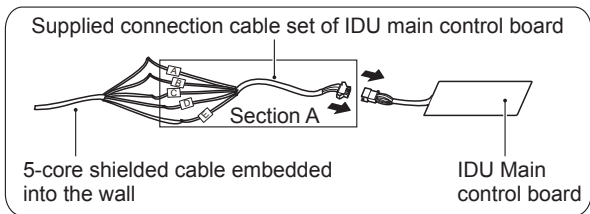

- Connect the cut end of section A (the end opposite to terminal A) to the 5-core shielded cable embedded in wall reliably, as shown in the above figure.
- Connect the cut end of section B (the end opposite to terminal B) to the 5-core shielded cable embedded in wall reliably, as shown in the figure below.

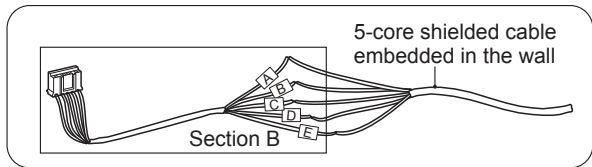

- Make sure that the five wiring terminals of the wired controller (A/B/C/D/E) correspond to those of the connection cable set (accessory) one by one.
- The shielded layer of 5-core shielded cable must be grounded.
- The longest wiring length of the system is 15 m.

2. Insert a slotted-head screwdriver into the bottom slot of the wired controller and rotate in the direction indicated to remove the rear cover of the wired controller, as shown in the figure below.

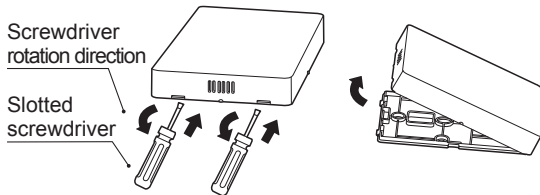

3. Pass section B of the connection cable set through the wiring hole in the rear cover of the wired controller, and fix the rear cover of wired controller on the wall using four plastic studs and the Philips head screws, as shown in the figure below.

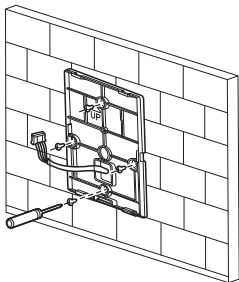

4. Connect terminal B to the 5-core socket in the PCB of the IDU main control board, as shown in the figure below.



CAUTION

After the terminal is properly connected, put the excess cable back to the hole on the wall (instead of leave it in the wired controller).

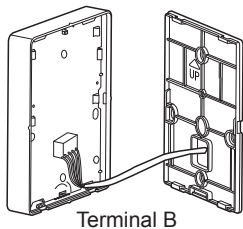

5. Knock the front cover of wired controller into the rear cover with the bottom buckles aligned first, as shown in the figure below.

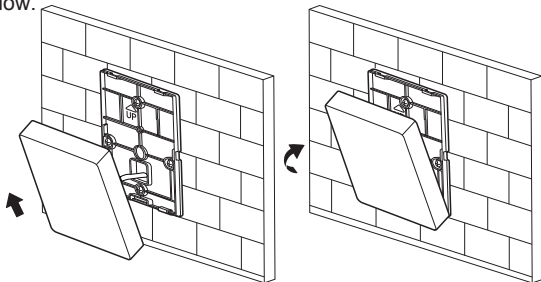



CAUTION

During installation, reserve a suitable length of the connecting cable for the wired controller so that the wired controller can be taken down in case of maintenance.

2.5 Schematic drawing of installation

Wiring with IDU:

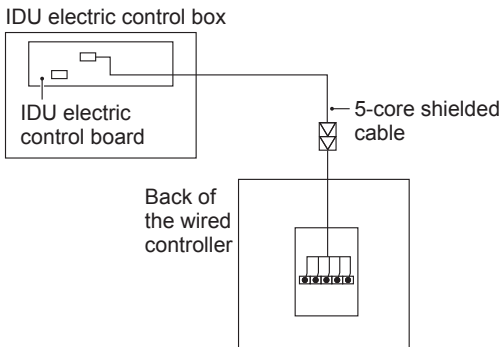

NOTE

A series of 18 horizontal dotted lines for writing notes.

16117100001793 V.F